



AOKE

 **ADD:** No.160 North Huanzhen Road, Science and Technology Park
Jiangshan Town, Yinzhou District, Ningbo City, 315191 Zhejiang China.

 **TEL:** +86-0574-88193751

 **EML:** alice@aokefurniture.com

 www.nbaoke.com
www.aokefurniture.com

AOKE FOSHAN BRANCH

 **ADD:** No.173 Longzhou West Road, Longjiang Town, Shunde District,
Foshan City, Guangdong China (Room 701-713, Block 3, Milanhui Home
Exhibition and Trade Center)

 **TEL:** +86-0575-23630550 / +86-13501537333

 **EML:** chenhaiguang@nbgitsmart.com

 www.nbaoke.com

AOKE EUROPE B.V.

 **ADD:** Edisonweg 10,6101, XJ Echt Netherland.

 **TEL:** +31(0)475 729 890

 **EML:** sales@aoke-europe.com

 www.aoke-europe.com

AOKE SOUTHEAST ASIA CO.,LTD.

 **ADD:** 29 Moo 2 2 T. Lad Sawai A. Lam Luk Ka Pathumtani 12150

 **TEL:** 0942152124

 **EML:** sale01@aokesa.com

 www.nbaoke.com

Rev.03



AOKE



AOKE-EUROPE



WECHAT OFFICIAL

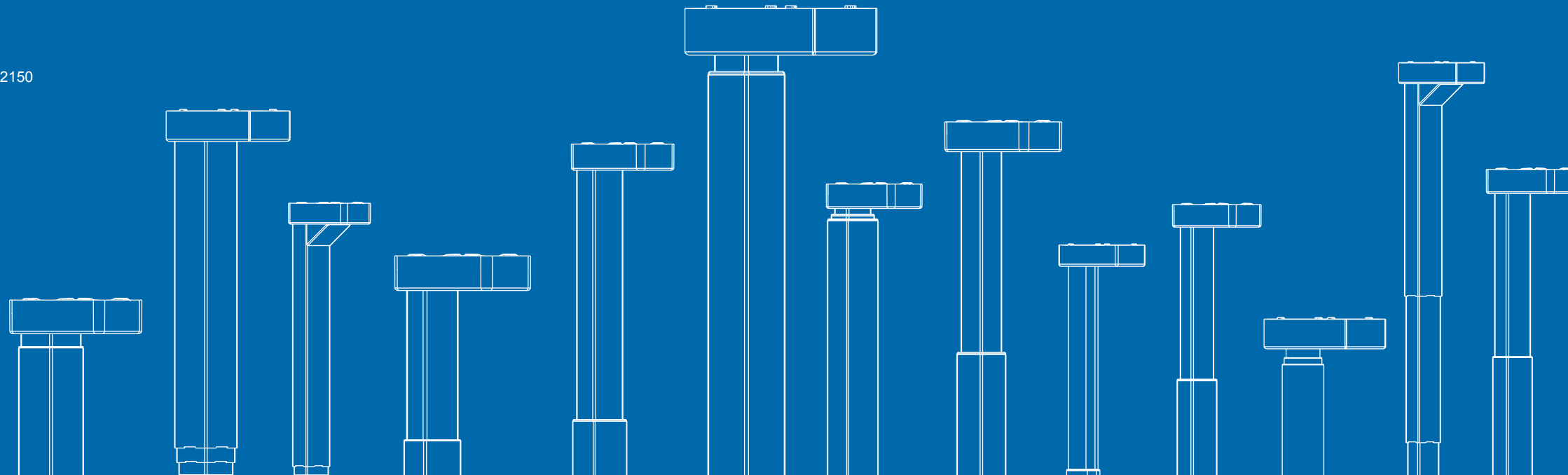

PRODUCT CATALOG



CONTENTS



Classic Series

Dual Motor Standing Desk Frame	05
Single Motor Standing Desk Frame	13
Hand Crank Standing Desk Frame	15
Three Legs Standing Desk Frame	17
Face To Face Workstation Frame	21



Whole Table Series

Touch Screen Glass-Top Standing Desk	27
RGB Light Gaming Desk	29
Standing Desk With Bluetooth Speakers	31
Pneumatic Standing Desk	33
Single Leg Electric Standing Desk	35
Dual Motor Standing Desk Without Beam	37



Desk Converter Series

Electric Desk Converter	43
Pneumatic Desk Converter	46



Accessories

Monitor Arm	51
Mobile Pedestal	55
Metal Cable Tray	57
Screen Clip	57
Control Box	57
Cable Management Spine	58
CPU Holder	58
Foot	58
Handset	59
Customizable Color	61
Column	63



Green
Health
Comfort

ABOUT AOKE

AOKE is a global designer and manufacturer of ergonomic standing desks, desk converters, ergonomic monitor arms, mobile pedestals, and other office accessories. We are established in 2012. Backed by an innovative and well-trained R&D team, extensive production capacity, and professional sales teams, AOKE empowers customers around the world to enjoy a more health-conscious workspace.

With over 485,000 sq.ft. of factory space, we use high-end production equipment such as laser-cutters, robotic welders, automatic CNC bending machines, automatic punches, automated powder coating paint lines, and a cutting edge inspection laboratory. This investment in precision manufacturing and quality assurance guarantee us high efficiency, and make sure our customers are provided with high quality products.

Following our rapid expansion, we added two new branches in the Netherlands and Thailand in 2017. We also set up two subsidiaries in the United States in 2019 and in Foshan, China in 2022 to provide a better experience for all customers.



01
Classic Series



**3-STAGE
OVAL TUBE
DUAL MOTOR
STANDING DESK FRAME**



AK2YJYT-ZT3

↑ Height Range
640-1290mm

⬆️ Rated Speed
40mm/s

👤 Rated Load
120kg

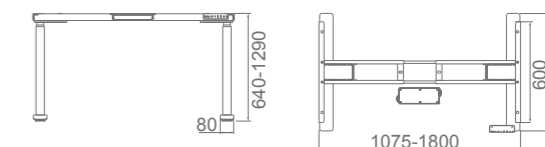

**2-STAGE
OVAL TUBE
DUAL MOTOR
STANDING DESK FRAME**



AK2YJYT-ZT2

↑ Height Range
690-1150mm

⬆️ Rated Speed
32mm/s

👤 Rated Load
120kg

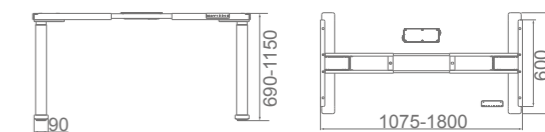



DUAL MOTOR STANDING DESK FRAME



DUAL MOTOR STANDING DESK FRAME



AK2YJYT-TYZB3

↑ Height Range
640-1290mm

⬆️ Rated Speed
40mm/s

👤 Rated Load
120kg

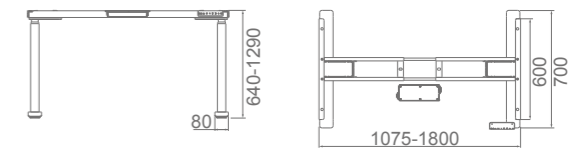

AK2YJYT-TYZF2

↑ Height Range
690-1150mm

⬆️ Rated Speed
32mm/s

👤 Rated Load
120kg

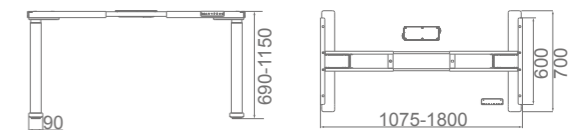



**QUICK ASSEMBLE
DUAL MOTOR
STANDING DESK FRAME**

🕒 Installation Time
10mins



**QUICK ASSEMBLE
DUAL MOTOR
STANDING DESK FRAME**

🕒 Installation Time
15mins



AK2YJKT-TYZB3K

↑ Height Range
640-1290mm

⬆️ Rated Speed
40mm/s

👤 Rated Load
100kg

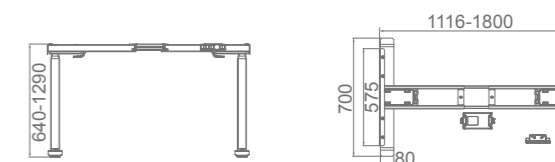

AK2YJKT-TYZB3

↑ Height Range
640-1290mm

⬆️ Rated Speed
40mm/s

👤 Rated Load
100kg

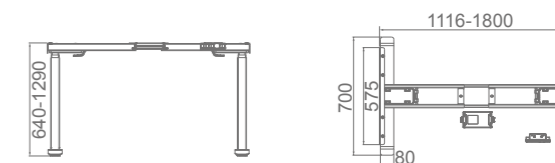



**DUAL MOTOR
TILTABLE STANDING
DESK FRAME**

AK2QX-YDZF3



 Tilt Angle
0~40 °

 Time
10s

 Max. Load when tilt
25kg

 Height Range
640-1290mm

 Rated Speed
40mm/s

 Rated Load
120kg

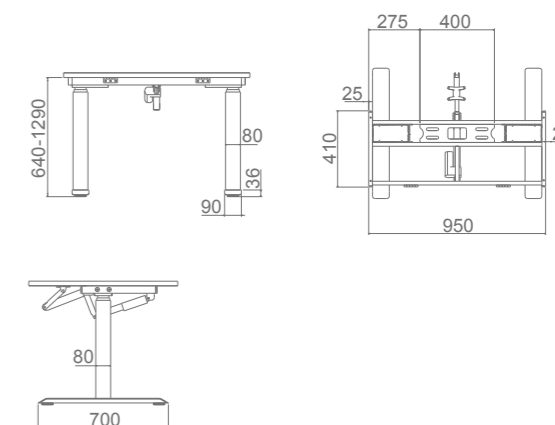



**SINGLE MOTOR
STANDING DESK
FRAME**



AK2YJYT-TY-A-F

↑ Height Range
715-1180mm

⚙️ Rated Speed
25mm/s

📦 Rated Load
100kg

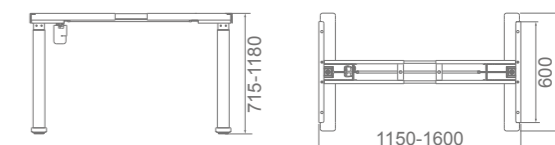

**SINGLE BEAM
SINGLE MOTOR
STANDING DESK FRAME**



AK02DHL-TY-AJ-M02

↑ Height Range
695-1145mm

⚙️ Rated Speed
20mm/s

📦 Rated Load
100kg

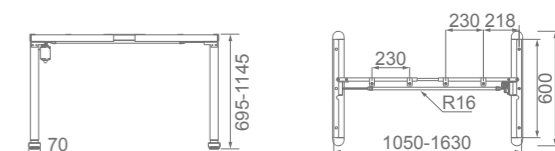



HAND CRANK STANDING DESK FRAME



AK2YJHT-Y-A-H

↑ Height Range
690-1130mm

⚙️ Rated Speed
6.12mm/r

👤 Rated Load
80kg

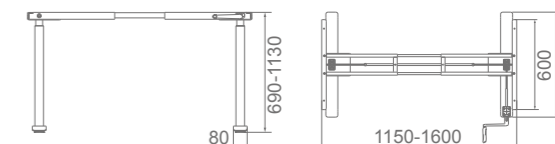

HAND CRANK STANDING DESK FRAME



AK2YJHRT-A-Y-SE

↑ Height Range
690-1130mm

⚙️ Rated Speed
16.7mm/r

👤 Rated Load
80kg

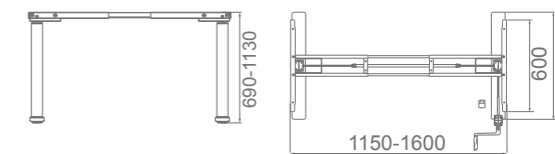



THREE LEGS STANDING DESK FRAME



AK3YJYT-TYZF3(90°)

↑ Height Range
640-1290mm

⚙️ Rated Speed
40mm/s

📦 Rated Load
150kg

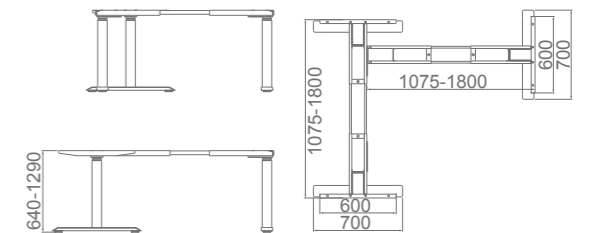

THREE LEGS STANDING DESK FRAME



AK3YJYT-TYZB2(90°)

↑ Height Range
690-1150mm

⚙️ Rated Speed
32mm/s

📦 Rated Load
150kg

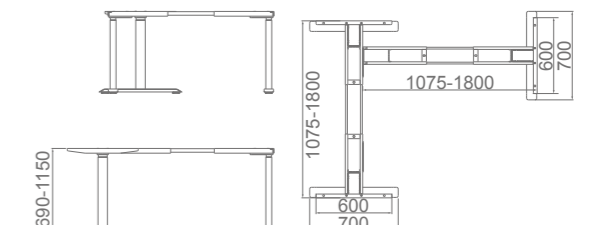



THREE LEGS STANDING DESK FRAME



AK3YJYT-TYZF3(90°/120°/180°)

↑ Height Range
640-1290mm

⚙️ Rated Speed
40mm/s

📦 Rated Load
150kg

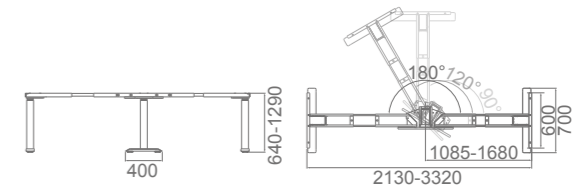

THREE LEGS STANDING DESK FRAME



AK3YJYT-TYZB2(90°/120°/180°)

↑ Height Range
690-1150mm

⚙️ Rated Speed
32mm/s

📦 Rated Load
150kg

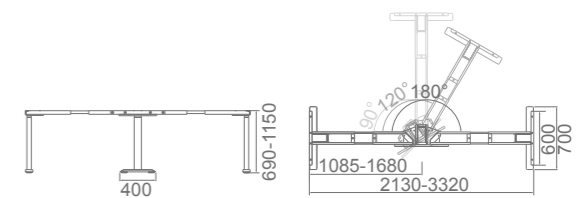



FACE TO FACE WORKSTATION FRAME



FACE TO FACE WORKSTATION FRAME



(AK2YJYT-TYZF3)*2



Height Range

640-1290mm



Rated Speed

40mm/s



Rated Load

120kg (Each Frame)

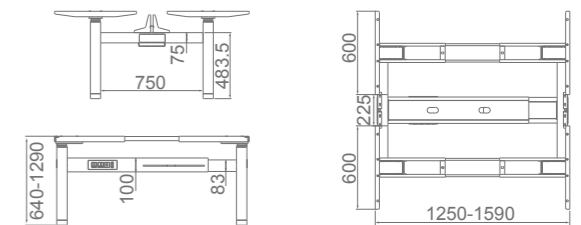

(AK2YJYT-TYZB2)*2



Height Range

690-1150mm



Rated Speed

32mm/s



Rated Load

120kg (Each Frame)

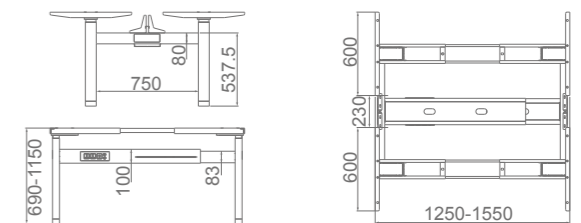



**FACE TO FACE
WORKSTATION
FRAME**



(AK02YJHT-A-H-E)*2

↑ **Height Range**
650-1090mm

⚙️ **Rated Speed**
6.12mm/r

📦 **Rated Load**
80kg (Each Frame)

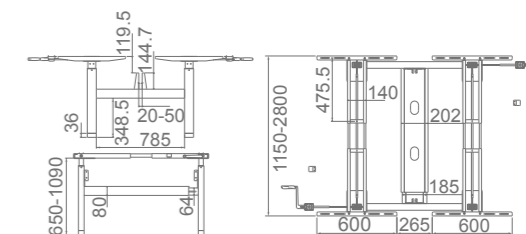

**FACE TO FACE
WORKSTATION
FRAME**



(AK02YJHT-A-L-E)*2

↑ **Height Range**
545-835mm

⚙️ **Rated Speed**
6.12mm/r

📦 **Rated Load**
80kg (Each Frame)

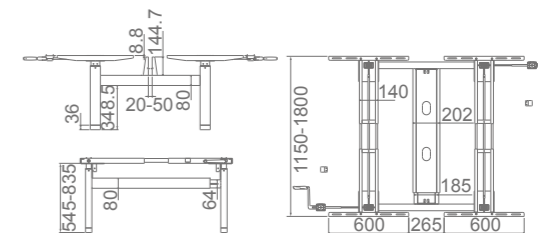

02
Whole Table Series



**TOUCH SCREEN
GLASS-TOP
STANDING DESK**

AK-GT01-YZF2

↑ **Height Range**
710-1160mm

⏱ **Rated Speed**
30mm/s

📦 **Rated Load**
100kg

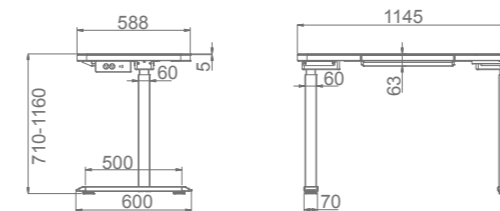

AK-GT10-YZF2

↑ **Height Range**
720-1170mm

⏱ **Rated Speed**
30mm/s

📦 **Rated Load**
100kg

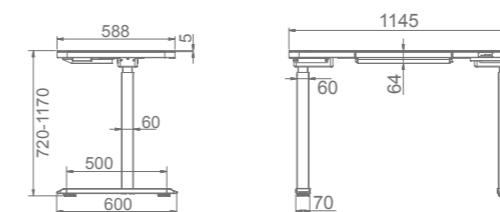



RGB LIGHT GAMING DESK

AK-DJ04-YZB2

↑ **Height Range**
710-1170mm

⚙️ **Rated Speed**
32mm/s

🔒 **Rated Load**
100kg

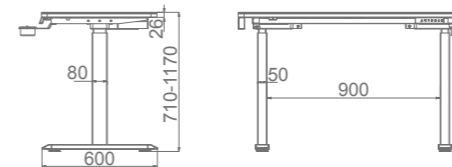

AK-DJ04

↑ **Height**
750±5mm

🔒 **Rated Load**
60kg

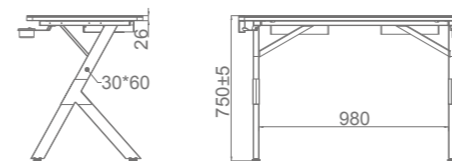



**STANDING DESK
WITH
BLUETOOTH
SPEAKERS**

AK-GT09-YZB2-S



 **Wireless Charging**

 **Bluetooth Speakers**

 **Touch-screen Handset**

 **Height Range**
710-1170mm

 **Rated Speed**
30mm/s

 **Rated Load**
100kg

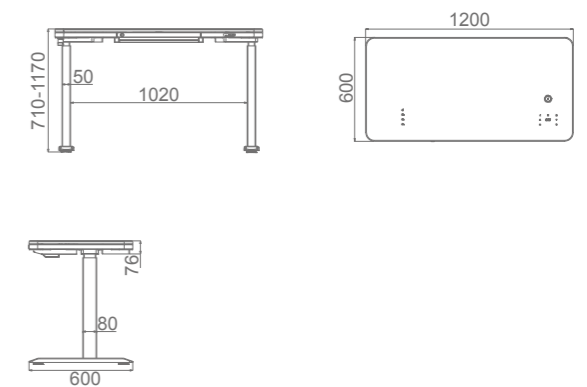



PNEUMATIC STANDING DESK



AK-MR-P20

↑ Height Range
760-1110mm

⚖ Static Rated Load
30kg

🔧 Dynamic Rated Load
6kg

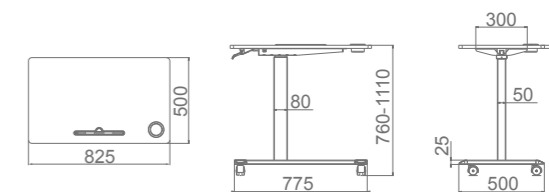

PNEUMATIC STANDING DESK

AK-MR-P07-4

↑ Height Range
705-1055mm

⚖ Static Rated Load
100kg

🔧 Dynamic Rated Load
13kg

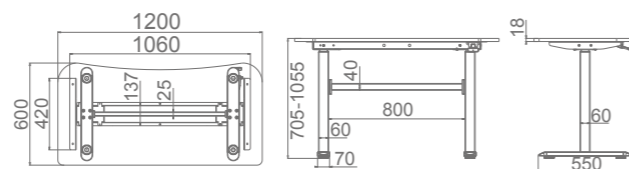



**SINGLE LEG
ELECTRIC
STANDING DESK**
AK-MR-P20-C



- ↑ **Height Range**
650-1100mm
- ⚙️ **Rated Speed**
28mm/s
- 📦 **Rated Load**
20kg

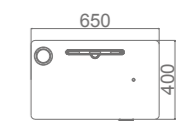
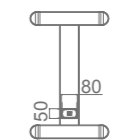
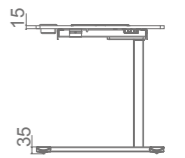
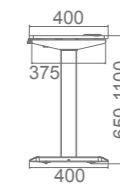



**DUAL MOTOR
STANDING DESK
WITHOUT BEAM**
AK2WHL-TYZB3-M02



- ↑ **Height Range**
640-1290mm
- ⚙️ **Rated Speed**
38mm/s
- 👤 **Rated Load**
100kg

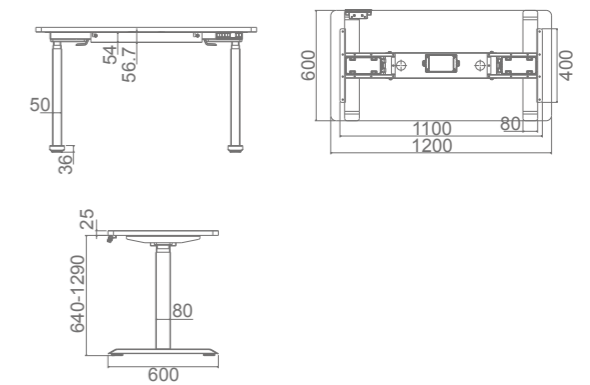

03

Desk Converter Series



ELECTRIC DESK CONVERTER WITH MONITOR MOUNT



Monitor Size



Rated Load

AK-MR-E01S	15" (MIN) ~40" (MAX)	10kg
AK-MR-E01D	15" (MIN) ~31.5" (MAX)	10kg
AK-MR-E01T	15" (MIN) ~19" (MAX)	8kg



AK-MR-E01S



AK-MR-E01D



AK-MR-E01T

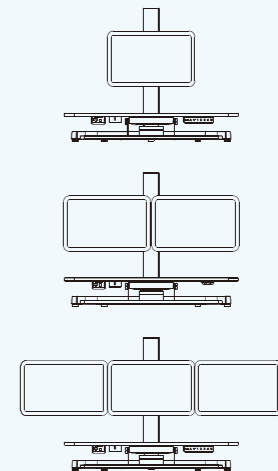
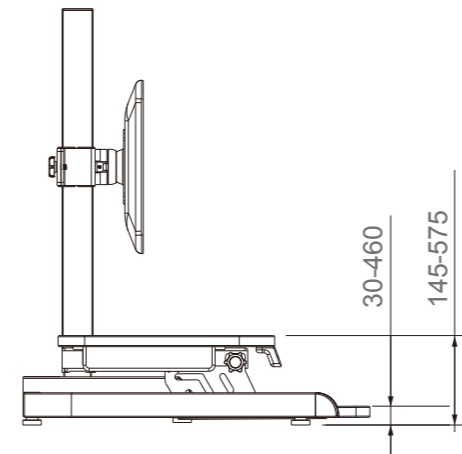
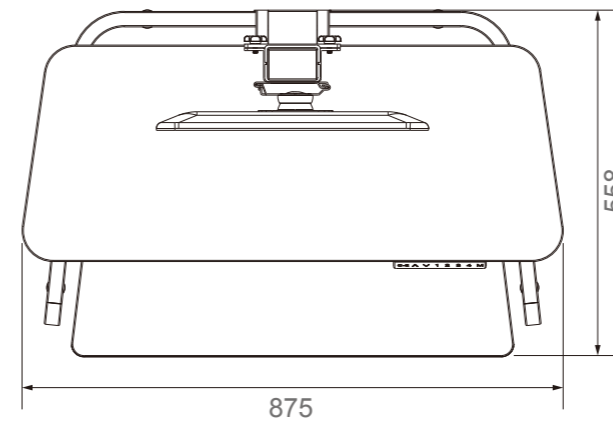

Height Range
145-575mm



Rated Speed
25mm/s



Rated Load
15kg

AK-MR-E03S

Electric



↑ Height Range For Top 150-550mm Desktop Rated Load 20kg

⬆️ Rated Speed 15mm/s Keyboard Rated Load 5kg

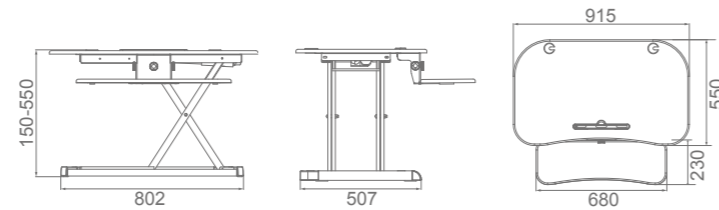

AK-MR-E07

Electric



↑ Height Range For Top 140-440mm Rated Load 20kg

⬆️ Rated Speed 20mm/s

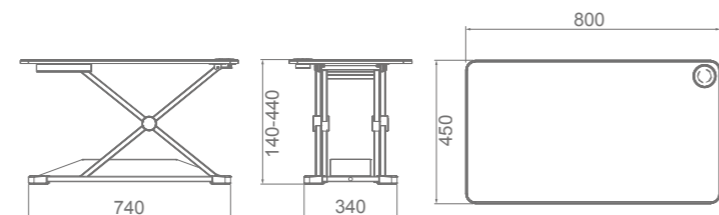

AK-MR-P23

Pneumatic



↑ Height Range For Top 155-500mm Desktop Rated Load 10kg

Keyboard Rated Load 2kg

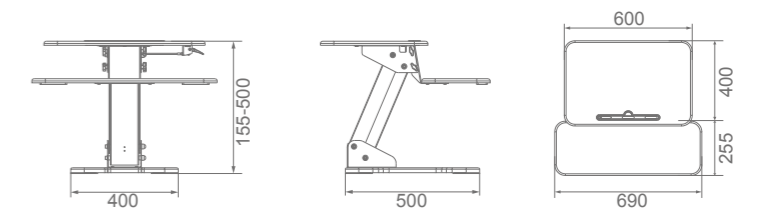

AK-MR-P24

Pneumatic



↑ Height Range For Top 155-500mm Desktop Rated Load 10kg

Keyboard Rated Load 2kg

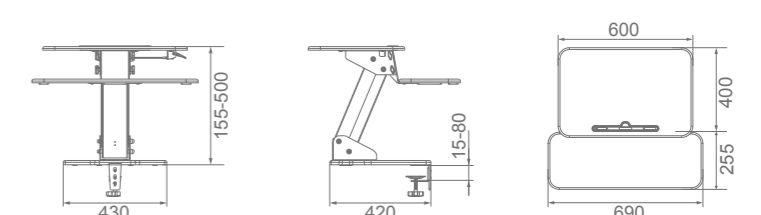

04
Accessories

SINGLE MONITOR ARM

Monitor Size
14"-32"
Height Range
28cm

METAL CABLE TRAY

Size
800*125*75mm

CPU HOLDER

Length
135-245mm
Height
300-455mm

CABLE MANAGEMENT SPINE

Length
1280mm
Size
68*36mm

DUAL MONITOR ARM





Monitor Size
14"-32"
Height Range
28cm

MOBILE PEDESTAL

Size
500*390*470mm

SINGLE MONITOR ARM

AK-MA01S-GS

 Monitor Size 14" -32"	 Height Range 28cm
 VESA Compatible 75*75 / 100*100mm	 Material ABS & Aluminum
 Weight Capacity 1-9kg	



tension adjustment for the up/down arm



tighten with desktop connection

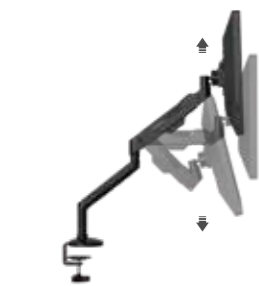

lift range: 333-611mm







tilt: ±40°



swivel: ±90°

DUAL MONITOR ARMS

AK-MA01D-GS

 Monitor Size 14" -32"	 Height Range 28cm
 VESA Compatible 75*75 / 100*100mm	 Material ABS & Aluminum
 Weight Capacity 1-9kg	



tension adjustment for the up/down arm



tighten with desktop connection



lift range: 333-611mm

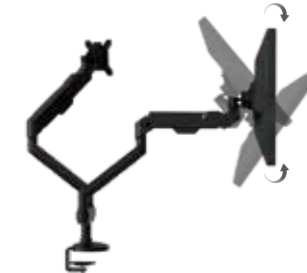





tilt: ±40°



swivel: ±90°

SINGLE MONITOR ARM

AK-MA02S

 <u>Monitor Size</u> 14" -32"	 <u>Height Range</u> 24cm
 <u>Rotation Angle</u> 360°	 <u>Material</u> ABS & Aluminum
 <u>Weight Capacity</u> 2-9kg	



tension adjustment for the up/down arm



tighten with desktop connection



easy installation (with cable management + bottom wire perforation)



lift range: 258-503mm





tilt: +90-50°

swivel: ± 90°

rotation: 360°

DUAL MONITOR ARMS

AK-MA02D

 <u>Monitor Size</u> 14" -32"	 <u>Height Range</u> 24cm
 <u>Rotation Angle</u> 360°	 <u>Material</u> ABS & Aluminum
 <u>Weight Capacity</u> 2-9kg	



tension adjustment for the up/down arm



tighten with desktop connection

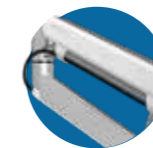

easy installation (with cable management + bottom wire perforation)



lift range: 258-503mm

tilt: +90-50°

swivel: ± 90°

rotation: 360°

MOBILE PEDESTAL

AK-PC-300

 Size
500*300*470mm

 Upper Drawer Size
460*238*70mm

 Lower Drawer Size
460*238*245mm



AK-PC-300-3L

 Size
500*300*470mm

 Upper Drawer Size
460*238*70mm

 Middle Drawer Size
460*238*70mm

 Lower Drawer Size
460*238*117mm



COLOR

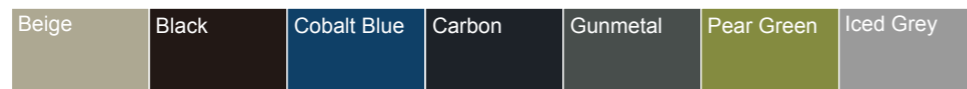

MOBILE PEDESTAL

AK-PC-390

 Size
500*390*470mm

 Upper Drawer Size
460*328*70mm

 Lower Drawer Size
460*328*245mm



AK-PC-390-3L

 Size
500*390*470mm

 Upper Drawer Size
460*328*70mm

 Middle Drawer Size
460*328*70mm

 Lower Drawer Size
460*328*117mm



COLOR

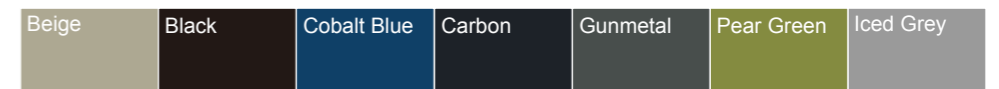

METAL CABLE TRAY



XC-SS01-100

↔ Adjustable Range
1000-1680mm

↔ Size
220*80mm

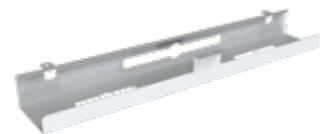

XC-WC01-800

↔ Size
800*125*75mm



XC-KZ01-855

↔ Size
856*113*20mm

SCREEN CLIP



AK-ZMPFJ

↔ Thickness with EVA Pad
3.5-15mm

↔ Thickness without EVA Pad
20-30mm



AK-ZMPFJ-4

↔ Thickness with EVA Pad
5-15mm

↔ Thickness without EVA Pad
20-30mm



PG003-T

↔ Thickness with EVA Pad
5-15mm

↔ Thickness without EVA Pad
20-30mm

CONTROL BOX

0.1W
standby power consumption



Type :
Integrated board 1control
Maximum Output:
29V DC, 2.5A



Type :
Integrated board 2control
Maximum Output:
32V DC, 6A



Type :
Integrated board 3control
Maximum Output:
32V DC, 6A

CABLE MANAGEMENT SPINE



— Length
1280mm

↔ Size
68*36mm

CPU HOLDER



AK-MF08

↔ Length
135-245mm

↔ Height
300-455mm

FOOT



AK-DJ-X01

Width:80/90mm
Matched Tube Shape:
Rectangle/Square/Round/Oval



AK-DJ-BG01

Width:70mm
Matched Tube Shape:
Rectangle/Oval



AK-DJ-P01

Width:80/90mm
Matched Tube Shape:
Rectangle/Square/Round/Oval



AK-DJ-QR01

Width:80/90mm
Matched Tube Shape:
Rectangle/Square/Round/Oval

HANDSET



TFH8

▲ ▼
Up / Down



TDH5

1/2/3/4
Memory Function Digit Display



TDH18P

1/2/3
Memory Function Digit Display Bluetooth Adapter (optional) USB Lock (optional)



TDH6

1/2/3/4
Memory Function Digit Display Bluetooth Adapter (optional)



TDH13P

1/2/3/4
Memory Function Digit Display Bluetooth Adapter (optional)



TDH20P

1/2
Memory Function Digit Display Bluetooth Adapter (optional) USB Lock (optional)



WP-H28

1/2/3/4
Memory Function Digit Display USB Bluetooth Adapter (optional)



WP-H32

1/2/3
Memory Function Digit Display



WP-H33/WP-H34

▲ ▼
Up / Down Digit Display (optional)



WP-H35

1/2/3
Memory Function Digit Display USB Lock



WP-H37

1/2/3/4
Memory Function Digit Display USB+ Type-C Vibration Feedback Touch Button



WP-H38

1/2
Memory Function Digit Display USB+ Type-C Touch Button Lighting Effects

Integrated Handset&Control Box



WP-H74/WP-H75

1/2/3
Memory Function Digit Display USB+ Type-C



WP-H72/WP-H73

▲ ▼
Up / Down USB



CUSTOMIZABLE COLOR

Take the actual color swatches as the criterion, support customization.

Classic Color



RAL9005



RAL7045

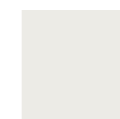

RAL9003

Other Colors



RAL7021



RAL7043



RAL7042



RAL9006



RAL7038

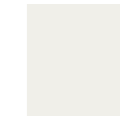

RAL9016



RAL1000



RAL1003



RAL2002



RAL2017



RAL3016



RAL3028



RAL4001



RAL4005



RAL4008



RAL5013



RAL5015



RAL5026



RAL6005



RAL6017



RAL6029



RAL7026



RAL8016



RAL9018

COLUMN

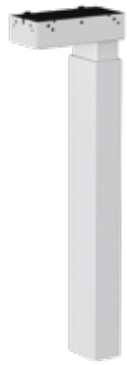

YDZB2
90*60mm
80*50mm



YZF2
60*60mm
50*50mm

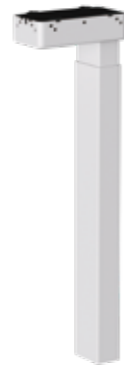

TYZB2
80*50mm
75*45mm



YZB3
90*60mm
80*50mm
70*40mm



YZF3
70*70mm
60*60mm
50*50mm



TYZB3
80*50mm
75*45mm
70*40mm

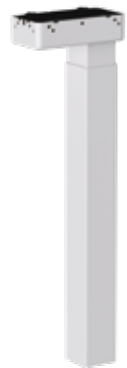

TYZF2
70*70mm
65*65mm



ZT2
91*58mm
83*50mm



ZY2
φ70mm
φ62mm



TYZF3
75*75mm
70*70mm
65*65mm



ZT3
91*58mm
83*50mm
75*42mm



ZY3
φ70mm
φ62mm
φ54mm



NZY3
φ70mm
φ63.5mm
φ57mm